

FIXOMULTIX

LA SOLUTION COMPLÈTE MULTICOUCHE POUR LES PROFESSIONNELS

LARGE GAMME DE RACCORDS

SOLUTION MULTIPROFIL

SYSTÈME ANTI-FUITE

DURÉE DE VIE 50 ANS



REF. 303XX-XX-XX

SÉCURITÉ ET FIABILITÉ

- Certifié NF par Afnor certification, certificat n°81351

APPLICATIONS

- Chauffage et/ou de distribution d'eau chaude/froide : chauffage, PCBT, sanitaire

CARACTÉRISTIQUES

- Bague de fixation en polyéthylène
- Douilles en inox de haute résistance garantissent un sertissage de qualité
- Joints toriques en EPDM conformes à la norme EN 681-1
- Équipés d'un système anti-fuite pour identifier toutes anomalies de sertissage lors de la mise en œuvre

PERFORMANCE

- Pression nominale de service : 10 bar
- Classe 2 : 10 bar - Alimentation en eau chaude sanitaire (et en eau froide sanitaire 20 °C/10 bar),
- Classe 4 : 10 bar - Radiateurs basse température, chauffage par le sol,
- Classe 5 : 6 bar - Radiateurs haute température,
- Classe « Eau glacée » : 10 bar.
- Classes 2, 4 et 5 conformes à la norme ISO 10508

PROFILS mâchoires

Ø	U	TH	H
16	■	■	■
20	■	■	■
26		■	■
32	■	■	■
40	■		
50	■		
63	■		
75	■		

Multiprofil U-TH-H jusqu'au diamètre 32, à l'exception du diamètre 26 : compatible profils TH-H. Compatible profil U uniquement pour les diamètres 40 à 75.



ATEC SYSTEM



LARGE GAMME JUSQU'AU Ø 75 MM



MULTIPROFIL CERTIFIÉ



SYSTÈME ANTI-FUITE



NF certificat 81351

* Pour les mâchoires : TH Ø 16, Ø 20, Ø 26, Ø 32 / H Ø 16, Ø 20, Ø 26 et Ø 32 / U Ø 16, Ø 20, Ø 32, Ø 40 à Ø 75.

AYOR W&H solutions - SAS au capital de 400 000 euros. RCS Périgueux n°681 980 033. 13 place Francheville - BP 202- 24052 Périgueux CT Cedex 9 - Tél. 05 53 02 69 70
Tous droits réservés. - AYOR se réserve le droit de changer ces caractéristiques sans préavis. - Garantie sur les défauts de matière et de fabrication.

ayor

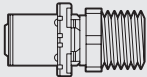
	Référence	Diamètre
RACCORD DROIT MÂLE		
	30311-16-12	16-3/8"
	30311-16-15	16x1/2"
	30311-16-20	16x3/4"
	30311-20-15	20x1/2"
	30311-20-20	20x3/4"
	30311-20-26	20x1"
	302011008	25-3/4"
	302011009	25-1"
	30311-26-20	26x3/4"
	30311-26-26	26x1"
	30311-32-26	32x1"
	30311-40-33	40x1"1/4
	30311-50-40	50x1"1/2
30311-63-50	63x2"	
30311-75-66	75x2"1/2	

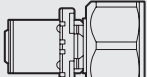
	Référence	Diamètre
RACCORD DROIT FEMELLE		
	30312-16-15	16x1/2"
	30312-16-20	16x3/4"
	30312-20-15	20x1/2"
	30312-20-20	20x3/4"
	30312-20-26	20x1"
	302011006	25-3/4"
	302011007	25-1"
	30312-26-20	26x3/4"
	30312-26-26	26x1"
	30312-32-26	32x1"
	30312-40-33	40x1"1/4
	30312-50-40	50x1"1/2
	30312-63-50	63x2"
30312-75-66	75x2"1/2	

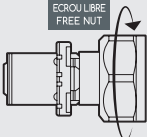
	Référence	Diamètre
DROIT FEMELLE ECR. TOURNANT		
	30314-16-12	16x3/8"
	30314-16-15	16x1/2"
	30314-16-20	16x3/4"
	30314-20-15	20x1/2"
	30314-20-20	20x3/4"
	302011101	25-3/4"
	302011102	25-1"
	30314-26-20	26x3/4"
	30314-26-26	26x1"
	30314-32-26	32x1"
	30314-32-33	32x1"1/4
	30314-32-40	32x1"1/2
	30314-40-33	40x1"1/4"
	30314-40-40	40x1"1/2
	30314-50-40	50x1"1/2
	30314-63-50	63x2"
	30314-75-66	75x2"1/2

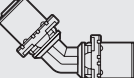
	Référence	Diamètre
COUDE ÉGAL 45°		
	302011206	25
	30325-26	26
	30325-32	32
	30325-40	40
	30325-50	50
	30325-63	63
	30325-75	75

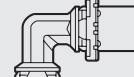
	Référence	Diamètre
COUDE ÉGAL 90°		
	30326-16	16
	30326-20	20
	302011205	25
	30326-26	26
	30326-32	32
	30326-40	40
	30326-50	50
	30326-63	63
	30326-75	75

COUDE FEMELLE À VISSER

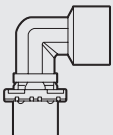
	Référence	Diamètre
	30361-16-15	16x1/2"
	30361-20-15	20x1/2"
	30361-20-20	20x3/4"
	302011305	25-3/4"
	302011306	25-1"
	30361-26-20	26x3/4"
	30361-26-26	26x1"
	30361-32-26	32x1"
	30361-40-40	40x1"1/2
	30361-50-40	50x1"1/2
	30361-63-50	63x2"

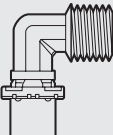
	Référence	Diamètre
COUDE MÂLE À VISSER		
	30362-16-12	16x3/8"
	30362-16-15	16x1/2"
	30362-20-15	20x1/2"
	30362-20-20	20x3/4"
	302011307	25-3/4"
	302011308	25-1"
	30362-26-20	26x3/4"
	30362-26-26	26x1"
	30362-32-26	32x1"
	30362-40-33	40x1"1/4
	30362-50-40	50x1"1/2
	30362-63-50	63x2"

	Référence	Diamètre
COUDE VISSER ECRU TOURNANT		
	30363-16-15	16x1/2"
	30363-16-20	16x3/4"
	302011401	25-3/4"
	30363-20-15	20x1/2"
	30363-20-20	20x3/4"
	30363-26-20	26x3/4"

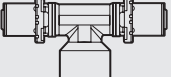
	Référence	Diamètre
TÉ FEMELLE AU CENTRE		
	30342-16-15	16x1/2"
	30342-20-15	20x1/2"
	30342-20-20	20x3/4"
	302011511	25-3/4"
	302011512	25-1"
	30342-26-15	26x1/2"
	30342-26-20	26x3/4"
	30342-32-15	32x1/2"
	30342-32-20	32x3/4"
	30342-32-26	32x1"
	302011501	40x1/2"
	302011502	40x3/4"
	302011503	40x1"
	302011504	50x1/2"
	302011505	50x3/4"
	302011506	50x1"
	302011507	63x1/2"
302011508	63x3/4"	
302011509	63x1"	

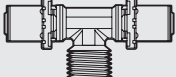
	Référence	Diamètre
TÉ MÂLE AU CENTRE		
	30341-16-15	16x1/2"
	30341-20-15	20x1/2"
	30341-20-20	20x3/4"
	302011510	25-3/4"
	30341-26-20	26x3/4"
	30341-32-26	32x1"

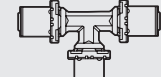
	Référence	Diamètre
TÉS ÉGAUX		
	30343-16-16-16	16x16x16
	30343-20-20-20	20x20x20
	302011627	25x25x25
	30343-26-26-26	26x26x26
	30343-32-32-32	32x32x32
	30343-40-40-40	40x40x40
	30343-50-50-50	50x50x50
	30343-63-63-63	63x63x63
	30343-75-75-75	75x75x75

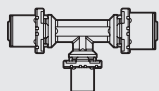
	Référence	Diamètre
TÉS RÉDUITS		
	30344-16-20-16	16x20x16
	30344-20-16-16	20x16x16
	30344-20-16-20	20x16x20
	30344-20-20-16	20x20x16
	302011625	20x25x20
	30344-20-26-20	20x26x20
	302011621	25x16x25
	302011615	25x16x16
	302011616	25x16x20
	302011617	25x20x15
	302011618	25x20x20
	302011622	25x20x25
	302011619	25x25x16
	302011628	25x25x20
	302011626	25x32x25
	30344-26-16-16	26x16x16
	30344-26-16-20	26x16x20
	30344-26-16-26	26x16x26
	30344-26-20-16	26x20x16
	30344-26-20-20	26x20x20
	30344-26-20-26	26x20x26
	30344-26-26-16	26x26x16
	30344-26-26-20	26x26x20
	30344-26-26-26	26x26x26
	30344-26-32-26	26x32x26
	30344-32-16-32	32x16x32
	30344-32-20-32	32x20x32
	302011620	32x25x25
302011623	32x25x32	

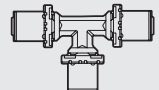
	Référence	Diamètre
	30344-32-26-26	32x26x26
	30344-32-26-32	32x26x32
	30344-40-20-40	40x20x40
	302011624	40x25x40
	30344-40-26-40	40x26x40
	30344-40-32-32	40x32x32
	30344-40-32-40	40x32x40
	30344-50-26-50	50x26x50
	30344-50-32-50	50x32x50
	30344-50-40-50	50x40x50
	30344-63-26-63	63x26x63
	30344-63-32-63	63x32x63
	30344-63-40-63	63x40x63
	30344-63-50-63	63x50x63
	30344-75-40-75	75x40x75
	30344-75-50-75	75x50x75

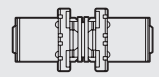
	Référence	Diamètre
MANCHON ÉGAL		
	30334-16	16
	30334-20	20
	302011627	25
	30334-26	26
	30334-32	32
	30334-40	40
	30334-50	50
	30334-63	63
	30334-75	75

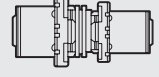
	Référence	Diamètre
MANCHON RÉDUIT		
	30335-20-16	20-16
	302011710	25-16
	302011711	25-20
	30335-26-16	26-16
	30335-26-20	26-20
	30335-32-20	32-20
	302011712	32-25
	30335-32-26	32-26
	302011713	40-25
	30335-40-26	40-26
	30335-40-32	40-32
	30335-50-32	50-32
	30335-50-40	50-40
	30335-63-40	63-40
	30335-63-50	63-50
	30335-75-50	75-50
	30335-75-63	75-63

BAGUE SERTISSAGE		
	3037-16	16
	3037-20	20
	302011803	25
	3037-26	26
	3037-32	32
	3037-40	40
	3037-50	50
	3037-63	63
3037-75	75	

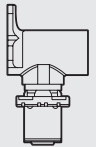
APPLIQUE SIMPLE		
	3035-16-15S	16x1/2"
	3035-20-15S	20x1/2"
	3035-20-20S	20x3/4"
	302011802	25x3/4"
	3035-26-20S	26x3/4"

APPLIQUE DOUBLE		
	3035-16-15D	16x1/2"
	3035-20-15D	20x1/2"

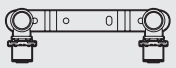
KIT APPLIQUE		
	3035-16-15	16x1/2"

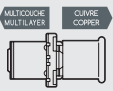
RACCORD DR CU/MC		
	MULTICOUCHE MULTILAYER	CUIRE COPPER
	30313-16-14	16/14
	30313-16-15	16/15
	30313-16-16	16/16
	30313-20-22	20/22

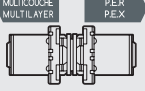
RACCORD PASSERELLE PER MC		
	MULTICOUCHE MULTILAYER	PER PEX
	3038-16-16	16/13x16
	3038-20-16	20/13x16
	3038-20-20	20/16x20
	3038-26-25	26/20x25